

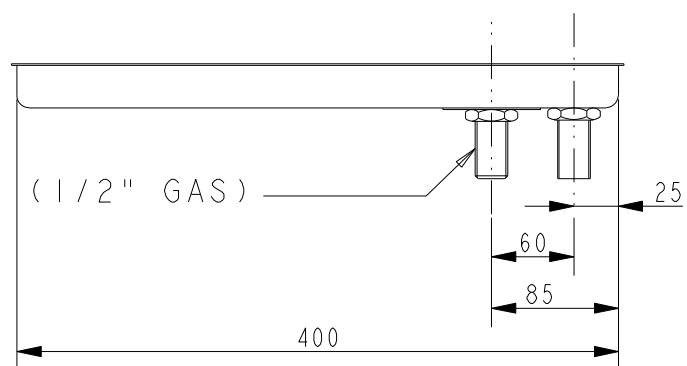

40X22 Aufbau-GLD-S

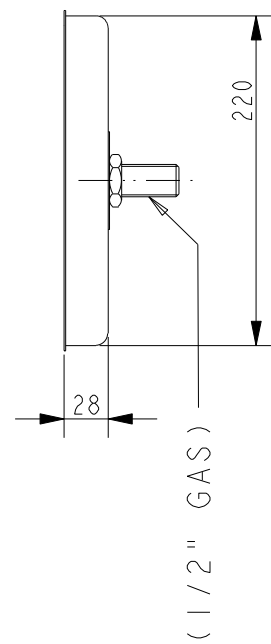

60X22 Aufbau-GLD-S

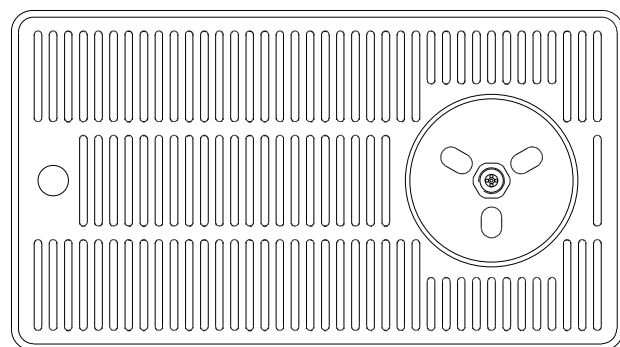
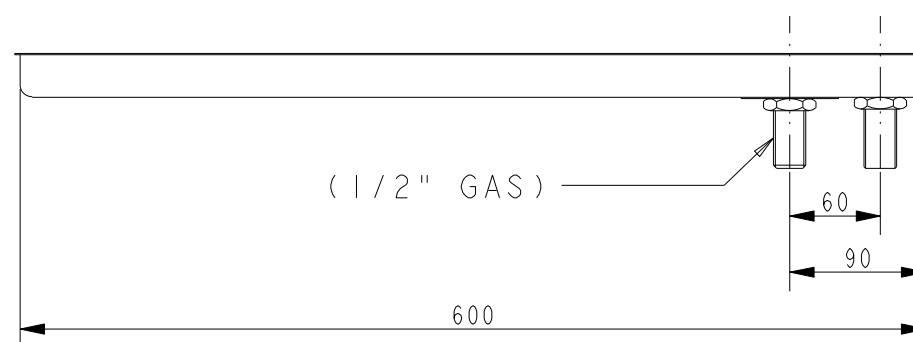
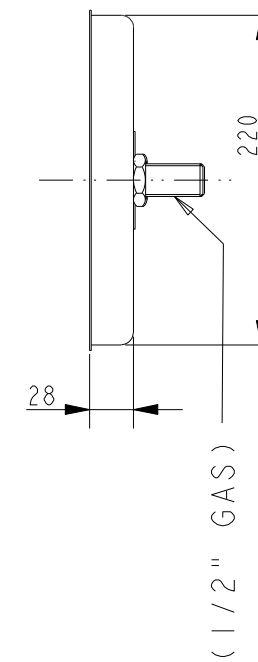
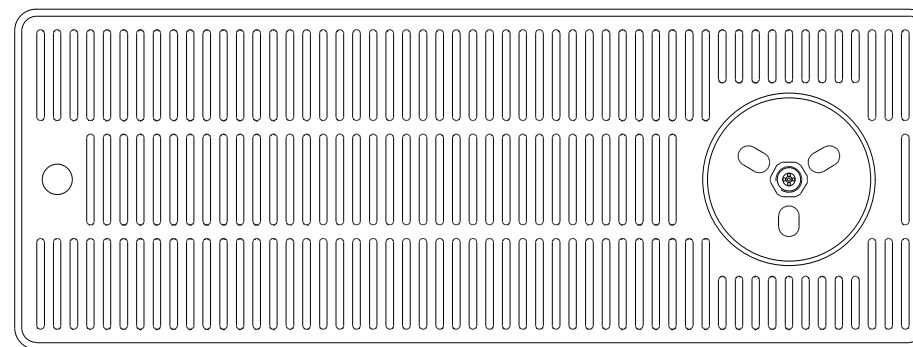

	Datum	Name	Benennung
Bearb.	12.07.2012	.	60x40x22-GLD-AUFSETZBAR-ABLAUF
Geprüft	.	.	
Ungültig	.	.	
			Format
			A3
			Maßstab
			1:5
			Zeichnungsnummer
			000000-BBBB-00000